



DESCRIPTION

The A6140 is a family of CMOS low dropout (LDO) voltage regulators that can deliver up to 150mA of current while consuming only 2µA of quiescent current (typical).

The input operating range is specified from 2.5V to 36V, making it an ideal choice for multi-cell battery systems, two to six primary cell battery-powered applications, 9V Alkaline and one or two cell li-Ion-powered applications, bus voltage power supply systems and other high DC voltage systems.

The wide input voltage can make it well withstand the impact of surge voltage and ensure the stability of output voltage.

Only 2uA (typical) at light load can reduce the standby power consumption of the whole system, which is high benefit in multi-battery power supply systems.

The A6140 is available in SOT-23 and SOT89-3 packages.

ORDERING INFORMATION

Package Type	Part Number	
SOT-23 SPQ: 3,000pcs/Reel	E3	A6140E3R-XX
		A6140E3VR-XX
SOT89-3 SPQ: 1,000pcs/Reel	K3	A6140K3R-XX
		A6140K3VR-XX
Note	XX: Output Voltage 30=3.0V, 33=3.3V, 36=3.6V, 50=5.0V V: Halogen free Package R: Tape & Reel	
AiT provides all RoHS products		

FEATURES

- 2µA Quiescent Current (typical)
- Input Operation Voltage Range: 2.5V to 36V
- 150mA Output Current
- Low Dropout Voltage
- Low Temperature Coefficient
- ±1% Output Voltage Accuracy
- Fixed 3.0V、3.3V、3.6V、and 5.0V Output
- Short Circuit Protection
- Over temperature Protection
- Available in SOT-23 and SOT89-3 packages

APPLICATION

- Battery-Powered Devices
- Battery-Powered Alarm Circuits
- Smoke Detectors
- CO² Detectors
- Pagers and cellular Phones
- Smart Battery Packs
- Low Quiescent Current Voltage Reference
- PDAs
- Digital Cameras
- Microcontroller Power
- Solar-Powered Instruments
- Consumer Products
- Battery Powered Data Loggers

TYPICAL APPLICATION

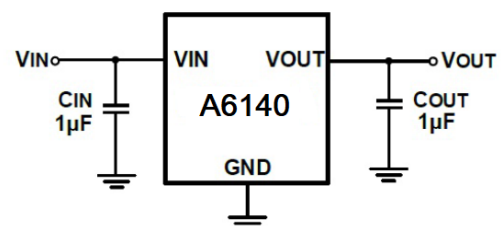



PIN DESCRIPTION

<p style="text-align: center;">Top View</p>		<p style="text-align: center;">Top View</p>	
Pin #		Symbol	Function
SOT-23	SOT89-3		
1	1	GND	Ground.
2	3	V _{OUT}	Regulator Output. Recommended output capacitor range: 1μF to 10μF.
3	2	V _{IN}	Regulator Input. Up to 36V input voltage. At least 1μF supply bypass capacitor is recommended.



ABSOLUTE MAXIMUM RATINGS

over operating free-air temperature range, unless otherwise noted^{NOTE1}

V _{IN} , Input Voltage	-0.3V ~ 40V
T _J , Junction Temperature	-40°C ~ 150°C
T _{STG} , Storage Temperature	-65°C ~ 150°C
ESD Ratings	
V _(ESD) , Electrostatic Discharge	Human-body model (HBM) ±4000V
	Machine model (MM) ±100V

Stress beyond above listed “Absolute Maximum Ratings” may lead permanent damage to the device. These are stress ratings only and operations of the device at these or any other conditions beyond those indicated in the operational sections of the specifications are not implied. Exposure to absolute maximum rating conditions for extended periods may affect device reliability.

NOTE1: All voltages are with respect to the GND pin.

RECOMMENDED OPERATING CONDITIONS

over operating free-air temperature range, unless otherwise noted^{NOTE1}

Parameter	Symbol	Min.	Max.	Unit
Input Supply Voltage	V _{IN}	2.5	36	V
Output Current	I _{OUT}	0	150	mA
Operating Temperature	T _A	-40	+85	°C



ELECTRICAL CHARACTERISTICS

$V_{IN} = V_{OUT} + 2V$, $C_{IN} = C_{OUT} = 1\mu F$, $V_{OUT} = 3.3V$, typical values are at $T_A = +25^\circ C$, unless otherwise noted.

Parameter	Symbol	Conditions	Min.	Typ.	Max.	Unit	
Input Voltage ^{NOTE3}	V_{IN}	$V_{OUT} = 3.3V$	-	-	36	V	
Output Voltage Accuracy		$I_{OUT} = 10mA$	-1	0	1	%	
Ground Pin Current		No load	-	2	3	μA	
Maximum Output Current ^{NOTE4}			70	100	150	mA	
Dropout Voltage ^{NOTE5}	V_{DROP}	$I_{OUT} = 100mA$, $\Delta V_o = 2\%$	-	526	-	mV	
Line Regulation	ΔV_{OUT}	$V_{IN} = V_{OUT} + 2V$ to 36V, $I_{OUT} = 1mA$	-	0.05	0.2	% / V	
	$\Delta V_{IN} \times V_{OUT}$						
Load Regulation	ΔV_{OUT}	$V_{IN} = V_{OUT} + 2V$, $I_{OUT} = 1mA$ to 50mA	-	25	60	mV	
Power Supply Rejection Ratio	PSRR	$V_{OUT} = 3.3V$, $I_{OUT} = 10mA$	$f = 217Hz$	-	58	-	dB
			$f = 1kHz$	-	40	-	
Output Voltage Temperature Coefficient ^{NOTE6}	ΔV_{OUT}	$-40^\circ C$ to $+85^\circ C$	-	100	-	ppm/ $^\circ C$	
	$\Delta T_A \times V_{OUT}$						
Thermal Shutdown Temperature	T_{SHDN}		-	150	-	$^\circ C$	



$V_{IN} = V_{OUT} + 2V$, $C_{IN} = C_{OUT} = 1\mu F$, $V_{OUT} = 5.0V$, typical values are at $T_A = +25^\circ C$, unless otherwise noted.

Parameter	Symbol	Conditions	Min.	Typ.	Max.	Unit	
Input Voltage ^{NOTE2}	V_{IN}	$V_{OUT} = 5.0V$	-	-	36	V	
Output Voltage Accuracy		$I_{OUT} = 10mA$	-1	0	1	%	
Ground Pin Current		No load $V_{IN} = V_{OUT} + 2V$	-	2	3	μA	
Maximum Output Current ^{NOTE3}			100	150	-	mA	
Dropout Voltage ^{NOTE4}	V_{DROP}	$I_{OUT} = 100mA$, $\Delta V_o = 2\%$	-	440	-	mV	
Line Regulation	ΔV_{OUT}	$V_{IN} = V_{OUT} + 2V$ to 36V, $I_{OUT} = 1mA$	-	0.05	0.2	%/V	
	$\Delta V_{IN} \times V_{OUT}$						
Load Regulation	ΔV_{OUT}	$V_{IN} = V_{OUT} + 2V$, $I_{OUT} = 1mA$ to 150mA	-	25	60	mV	
Power Supply Rejection Ratio	PSRR	$V_{OUT} = 5.0V$, $I_{OUT} = 10mA$	$f = 217Hz$	-	58	-	dB
			$f = 1kHz$	-	40	-	
Output Voltage Temperature Coefficient ^{NOTE5}	ΔV_{OUT}	$-40^\circ C$ to $+85^\circ C$	-	100	-	ppm/ $^\circ C$	
	$\Delta T_A \times V_{OUT}$						
Thermal Shutdown Temperature	T_{SHDN}		-	150	-	$^\circ C$	

NOTE2: $V_{IN} \geq V_{OUT(NOMINAL)}$, whichever is greater.

NOTE3: Maximum output current is affected by the PCB layout, size of metal trace, the thermal conduction path between metal layers, ambient temperature and the other environment factors of system. Attention should be paid to the dropout voltage when $V_{IN} < V_{OUT} + V_{DROP}$.

NOTE4: The dropout voltage is defined as $V_{IN} - V_{OUT}$, when V_{OUT} is 100mV below the value of V_{OUT} for $V_{IN} = V_{OUT(NOMINAL)} + 2V$.

NOTE5: Output voltage temperature coefficient is defined as the worst-case voltage change divided by the total temperature range.



ATYPICAL PERFORMANCE CHARACTERISTICS

$V_{IN} = 5.3V$, $V_{OUT} = 3.0V$, $C_{IN} = C_{OUT} = 1\mu F$, $T_A = 25^\circ C$ unless otherwise noted.

1. Line Transient Response

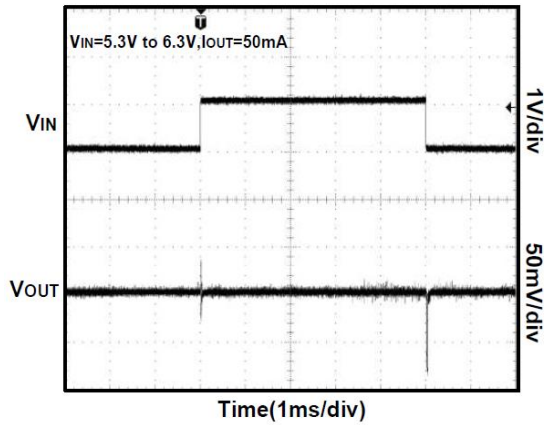

2. Load Transient Response

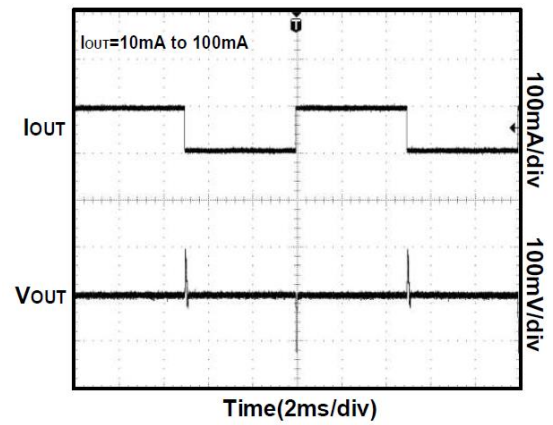

3. Power-Up/Power-Down Output Waveform

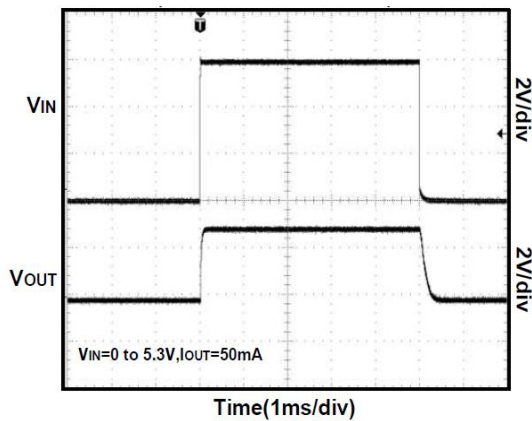

4. Output Short Waveform

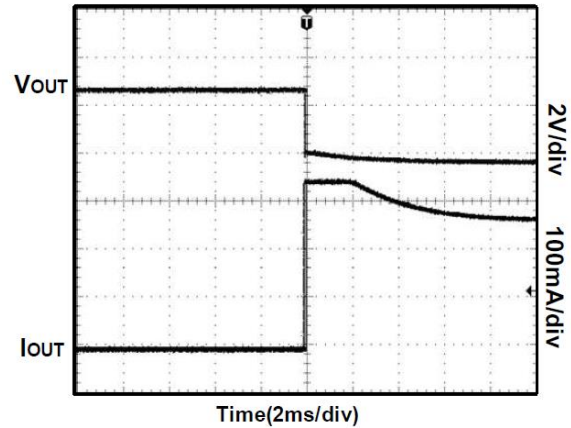

5. Dropout Voltage vs. Temperature

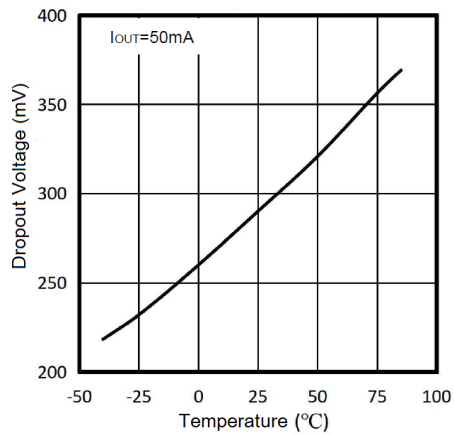

6. Dropout Voltage vs. Output Current

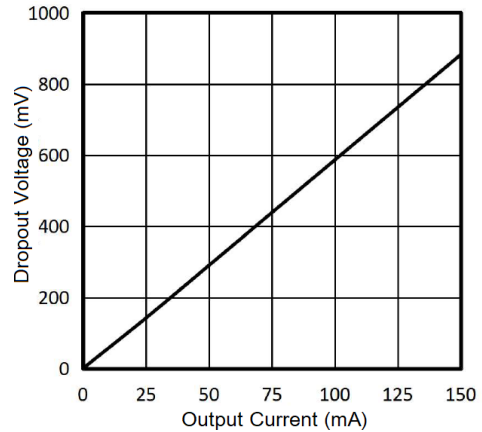



7. Ground Pin Current vs. Input Voltage

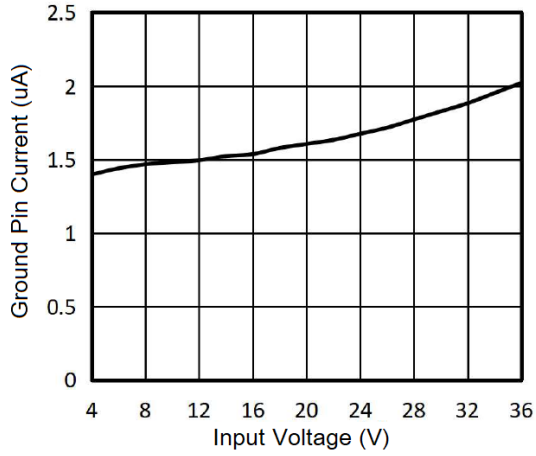

8. Ground Pin Current vs. Load Current

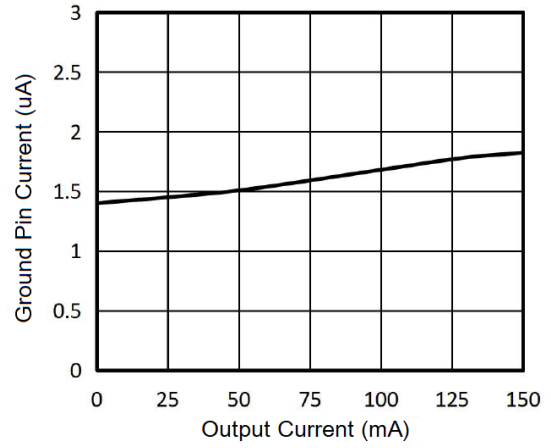



BLOCK DIAGRAM

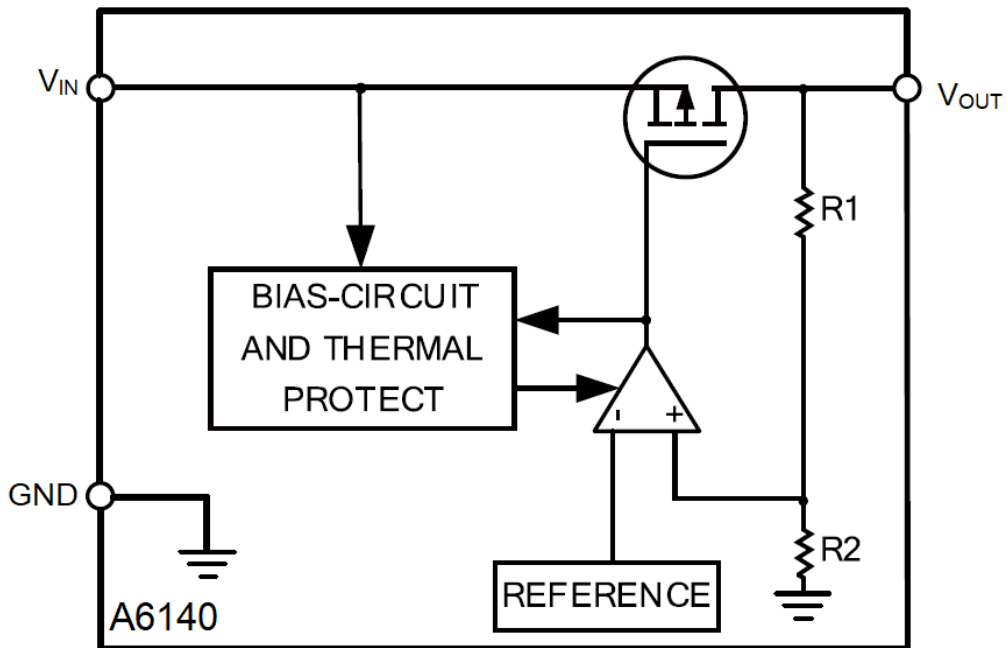



DETAILED INFORMATION

Overview

The A6140 low-dropout regulators (LDO) consumes only 2 μ A of quiescent current at light load and delivers excellent line and load transient performance. These characteristics, combined with low noise and good PSRR with low dropout voltage, make this device ideal for portable consumer applications.

Thermal Considerations

When the junction temperature is too high, the thermal protection circuitry sends a signal to the control logic that will shut down the IC. The IC will restart when the temperature has sufficiently cooled down. The maximum power dissipation is dependent on the thermal resistance of the case and the circuit board, the temperature difference between the die junction and the ambient air, and the rate of air flow. The GND pin must be connected to the ground plane for proper dissipation.

Applications Note:

1. The phase compensation circuit and ESR of the output capacitor are used inside the circuit to compensate, so a capacitor larger than 1.0 μ F must be connected to the ground.
2. It is recommended to use 1 μ F polar capacitors for input and output, and to keep the capacitors as close to the V_{IN} and V_{OUT} pins of LDO as possible.
3. Pay attention to the use conditions of input and output voltages and load currents to avoid the power consumption (PD) inside the IC exceeding the maximum power consumption allowed by the package.

$$P_D = (V_{IN} - V_{OUT}) \times I_{OUT}$$

$$T_{PN} = P_D \times R_{\theta JA} + T$$

T_{PN} is junction temperature

T is ambient temperature.

4. When the input voltage V_{IN} is greater than 2.5V, if V_{IN} is also higher than the output set value plus the device dropout voltage, V_{OUT} is equal to the set value. Otherwise, V_{OUT} is equal to V_{IN} minus the dropout voltage. If V_{IN} lower than 2.5V, the V_{OUT} is:

$$V_{OUT} = V_{IN} - V_{Dropout}$$



PACKAGE INFORMATION

Dimension in SOT-23 (Unit: mm)

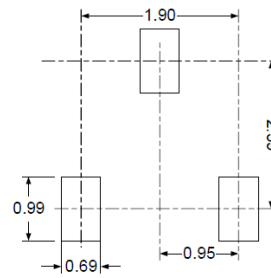
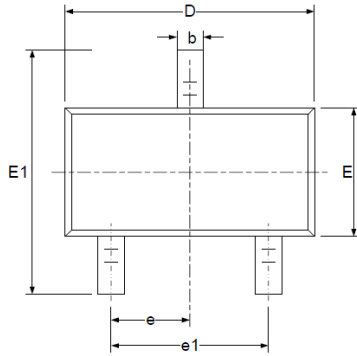

RECOMMENDED LAND PATTERN (Unit: mm)

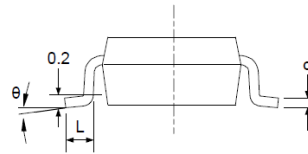
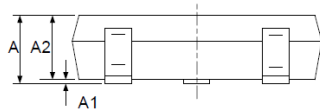

Symbol	Millimeters		Inches	
	Min	Max	Min	Max
A	1.050	1.250	0.041	0.049
A1	0.000	0.100	0.000	0.004
A2	1.050	1.150	0.041	0.045
b	0.300	0.500	0.012	0.020
c	0.100	0.200	0.004	0.008
D	2.820	3.020	0.111	0.119
E	1.500	1.700	0.059	0.067
E1	2.650	2.950	0.104	0.116
e	0.950 BSC		0.037 BSC	
e1	1.800	2.000	0.071	0.079
L	0.300	0.600	0.012	0.024
θ	0°	8°	0°	8°



Dimension in SOT89-3 (Unit: mm)

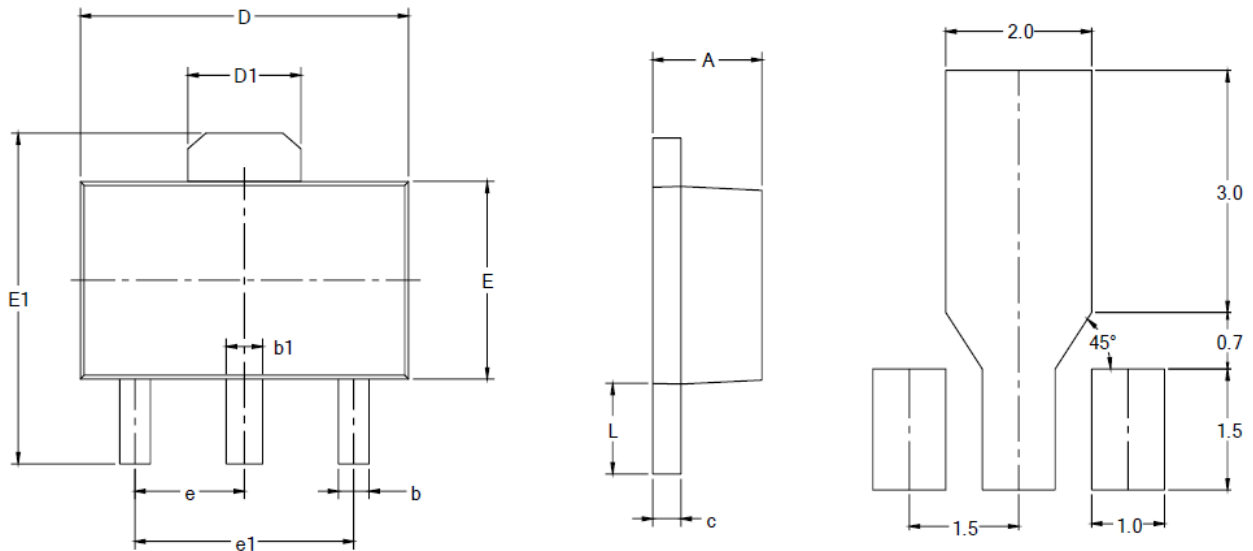

RECOMMENDED LAND PATTERN (Unit: mm)

Symbol	Millimeters		Inches	
	Min	Max	Min	Max
A	1.400	1.600	0.055	0.063
b	0.320	0.520	0.013	0.020
b1	0.400	0.580	0.016	0.023
c	0.350	0.440	0.014	0.017
D	4.400	4.600	0.173	0.181
D1	1.550 REF		0.061 REF	
E	2.300	2.600	0.091	0.102
E1	3.940	4.250	0.155	0.167
e	1.500 BSC		0.060 BSC	
e1	3.000 BSC		0.118 BSC	
L	0.900	1.200	0.035	0.047



IMPORTANT NOTICE

AiT Semiconductor Inc. (AiT) reserves the right to make changes to any its product, specifications, to discontinue any integrated circuit product or service without notice, and advises its customers to obtain the latest version of relevant information to verify, before placing orders, that the information being relied on is current.

AiT Semiconductor Inc.'s integrated circuit products are not designed, intended, authorized, or warranted to be suitable for use in life support applications, devices or systems or other critical applications. Use of AiT products in such applications is understood to be fully at the risk of the customer. As used herein may involve potential risks of death, personal injury, or severe property, or environmental damage. In order to minimize risks associated with the customer's applications, the customer should provide adequate design and operating safeguards.

AiT Semiconductor Inc. assumes to no liability to customer product design or application support. AiT warrants the performance of its products of the specifications applicable at the time of sale.