



DESCRIPTION

AM7246A is the N-Channel enhancement mode power field effect transistors are using trench DMOS technology. This advanced technology has been especially tailored to minimize on-state resistance, provide superior, fast switching performance, and withstand high energy pulse in the avalanche and commutation mode.

AM7246A is available in a DFN8(3.3x3.3) package.

ORDERING INFORMATION

Package Type	Part Number	
DFN8 SPQ: 3,000pcs/Reel	J8	AM7246AJ8R
		AM7246AJ8VR
Note	V: Halogen free Package R: Tape & Reel	
AiT provides all RoHS products		

FEATURES

- $V_{DS} = 60V, I_D = 40A$
 $R_{DS(ON)}=9m\Omega(Typ.)@V_{GS}=10V$
 $R_{DS(ON)}=10m\Omega(Typ.)@V_{GS}=4.5V$
- 100% UIS and Rg tested
- Available in a DFN8(3.3x3.3) package.

APPLICATION

- Motor Control
- LED Lighting
- DC/DC Converters

PIN DESCRIPTION

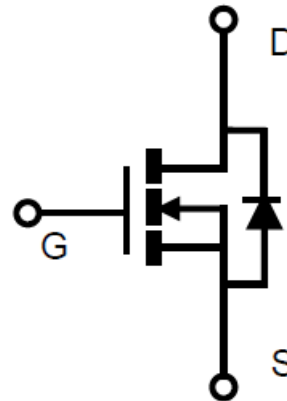



PIN DESCRIPTION

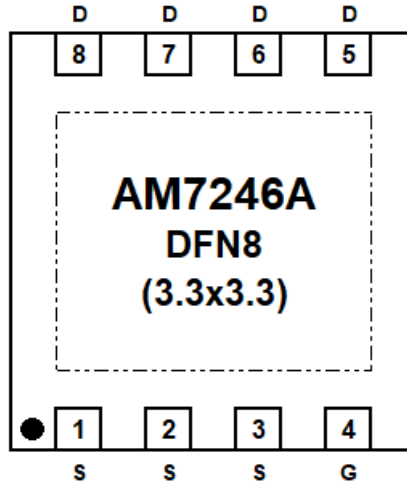

Top View

Pin #	Symbol	Function
1	S	Source
2	S	Source
3	S	Source
4	G	Gate
5	D	Drain
6	D	Drain
7	D	Drain
8	D	Drain



ABSOLUTE MAXIMUM RATINGS

T_A = 25°C, unless otherwise noted

V _{DSS} , Drain-Source Voltage		60V
V _{GSS} , Gate-Source Voltage		±20V
I _D , Continuous Drain Current	T _C =25°C	40A
	T _C =100°C	25A
I _{DM} , Pulsed Drain Current ^{NOTE1}		160A
I _D , Continuous Drain Current	T _A =25°C	13.5A
	T _A =70°C	10.8A
P _D , Power Dissipation ^{NOTE2}	T _A =25°C	4.2W
	T _A =70°C	2.7W
I _{AS} , Avalanche Current ^{NOTE1}		35A
E _{AS} , Single Pulse Avalanche energy L=0.1mH ^{NOTE1,6}		61mJ
P _D , Power Dissipation ^{NOTE3}	T _C =25°C	35.7W
	T _C =100°C	14.3W
T _J , Operation Junction Temperature		-55°C~+150°C
T _{STG} , Storage Temperature Range		-55°C~+150°C

Stress beyond above listed "Absolute Maximum Ratings" may lead permanent damage to the device. These are stress ratings only and operations of the device at these or any other conditions beyond those indicated in the operational sections of the specifications are not implied. Exposure to absolute maximum rating conditions for extended periods may affect device reliability.

THERMAL CHARACTERISTICS

Parameter		Symbol	Typ.	Max.	Units
Thermal Resistance Junction to Ambient ^{NOTE2}	t ≤ 10s	R _{θJA}	-	30	°C/W
Thermal Resistance Junction to Ambient ^{NOTE2,4}	Steady-State		-	65	
Thermal Resistance Junction to Case	Steady-State	R _{θJC}	-	3.5	

NOTE1: Pulsed width limited by maximum junction temperature, T_{J(MAX)}=150°C.

NOTE2: The value of R_{θJA} is measured with the device mounted on 1in² FR-4 board in a still air environment with maximum junction temperature T_{J(MAX)}=150°C (initial temperature T_A=25°C).

NOTE3: T_{J(MAX)}=150°C, using junction-to-ambient thermal resistance, t ≤ 10sec.

NOTE4: T_{J(MAX)}=150°C, using junction-to-case thermal resistance (R_{θJC}) is more useful in additional heat sinking is used.

NOTE5: The data tested by pulsed, pulse width ≤ 300μs, duty cycle ≤ 2%.

NOTE6: The E_{AS} data shows Max, tested and pulse width limited by T_{J(MAX)}=150°C (initial temperature T_J=25°C).



ELECTRICAL CHARACTERISTICS

T_A = 25°C, unless otherwise noted

Parameter	Symbol	Conditions	Min	Typ.	Max	Units
Static Parameters						
Drain-Source Breakdown Voltage	BV _{DSS}	V _{GS} =0V, I _D =250μA	60	-	-	V
Gate Threshold Voltage	V _{GS(th)}	V _{DS} =V _{GS} , I _D =250μA	1	1.6	2.5	V
Gate Leakage Current	I _{GSS}	V _{DS} =0V, V _{GS} =±20V	-	-	±100	nA
Zero Gate Voltage Drain Current	I _{DSS}	V _{DS} =60V, V _{GS} =0V T _J =25°C	-	-	1	μA
		V _{DS} =48V, V _{GS} =0V T _J =75°C	-	-	10	
Drain-source On-Resistance ^{NOTE5}	R _{DS(ON)}	V _{GS} =10V, I _D =13.5A	-	9	12	mΩ
		V _{GS} =4.5V, I _D =8A	-	10	14	
Forward Transconductance	G _{fs}	V _{DS} =10V, I _D =10A	-	15	-	S
Diode Characteristics						
Diode Forward Voltage ^{NOTE5}	V _{SD}	I _S =1A, V _{GS} =0V	-	0.7	1	V
Continuous Source Current	I _S		-	-	40	A
Reverse Recovery Time	t _{rr}	I _S =10A, di/dt=100A/μs	-	18	-	ns
Reverse Recovery Charge	Q _{rr}		-	38	-	nC
Dynamic and Switching Parameters						
Total Gate Charge (10V)	Q _g	V _{DS} =30V, V _{GS} =10V, I _D =10A	-	38.8	54.3	nC
Total Gate Charge (4.5V)	Q _g		-	18.5	25.9	
Gate-Source Charge	Q _{gs}		-	6.2	8.7	
Gate-Drain Charge	Q _{gd}		-	9.3	13	
Input Capacitance	C _{iss}	V _{DS} =30V, V _{GS} =0V, f=1.0MHz	-	2050	-	pF
Output Capacitance	C _{oss}		-	172	-	
Reverse Transfer Capacitance	C _{rss}		-	72	-	
Gate Resistance	R _g	V _{GS} =0V, V _{DS} =0V, f=1MHZ	-	1.6	-	Ω
Turn-On Time ^{NOTE5}	t _{d(on)}	V _{DD} =30V, V _{GS} =10V, R _G =6Ω, I _D =1A	-	14	27	ns
	t _r		-	22	42	
Turn-Off Time ^{NOTE5}	t _{d(off)}		-	38	72	
	t _f		-	11	21	



TYPICAL CHARACTERISTICS

1. Output Characteristics

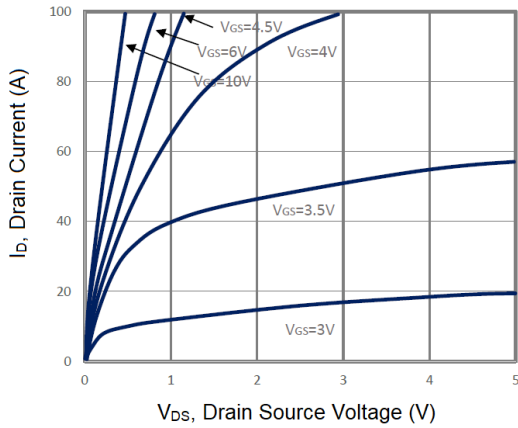

2. Drain-Source On Resistance

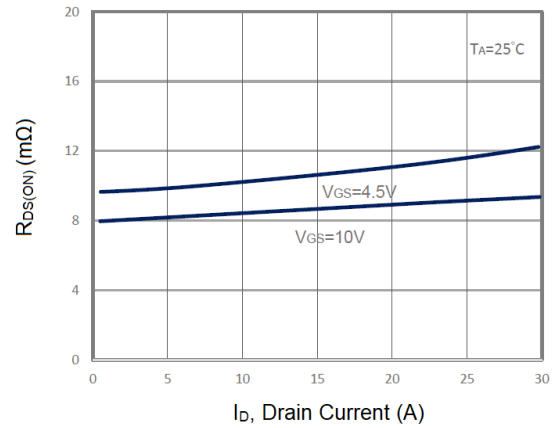

3. Gate Charge

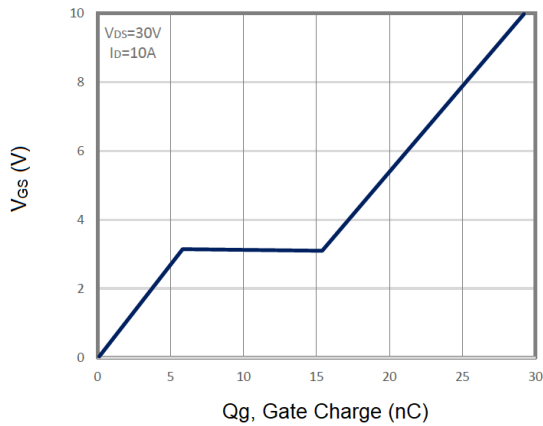

4. Capacitance

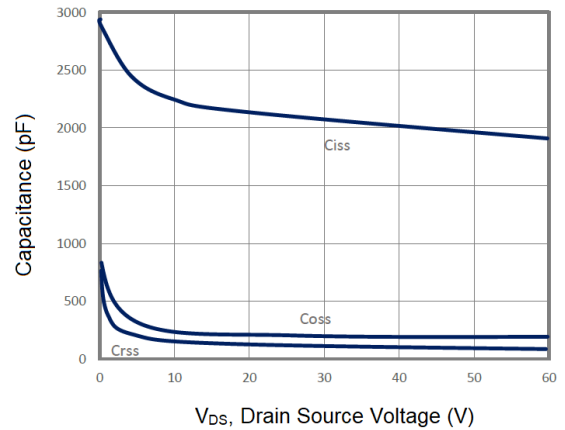

5. Gate Threshold Voltage

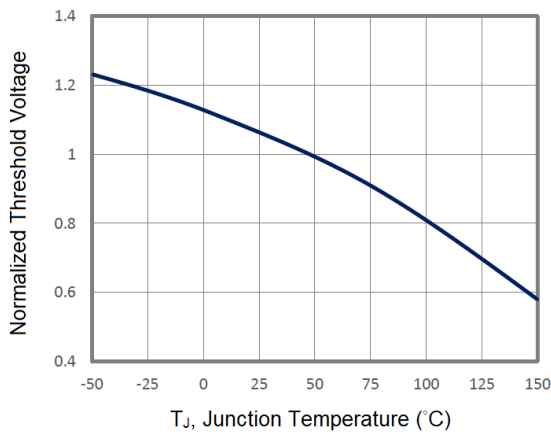

6. Power Dissipation

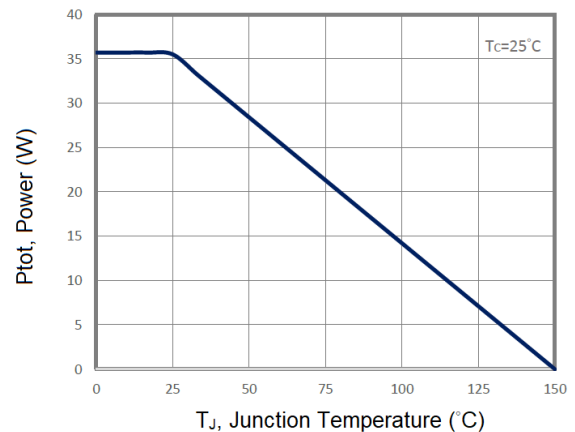



7. $R_{DS(ON)}$ vs. Junction Temperature

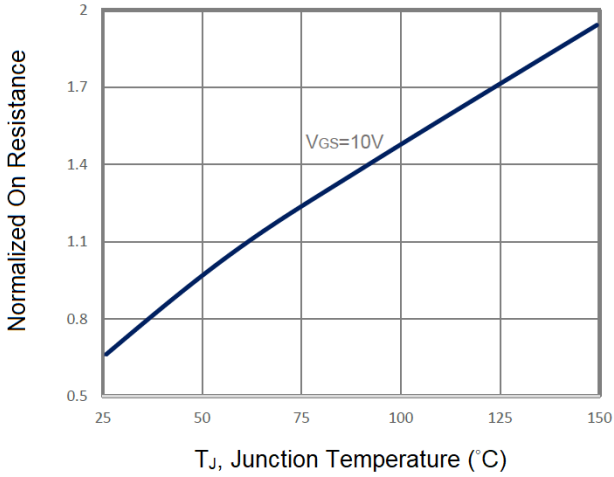

8. Drain Current vs. T_C

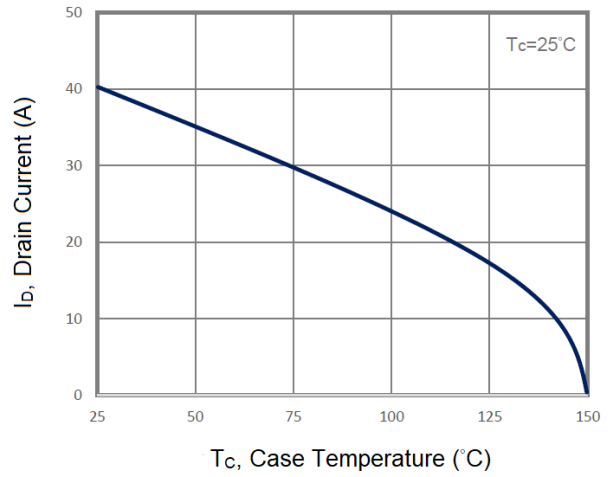

9. Maximum Safe Operation Area

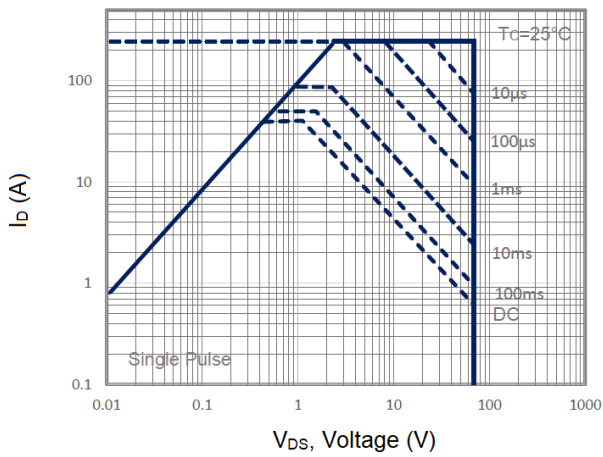

10. Thermal Transient Impedance

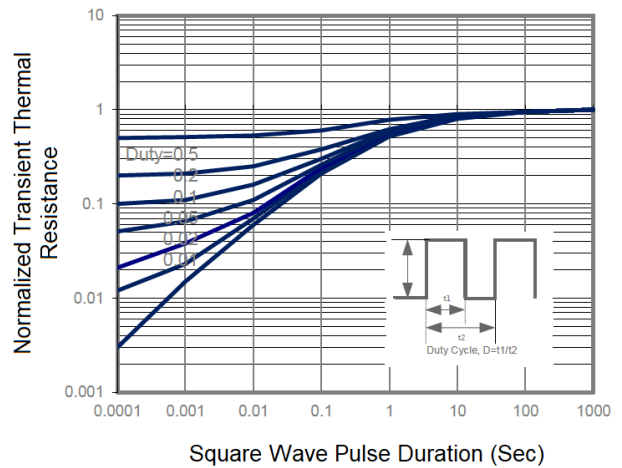

11. Gate Charge Waveform

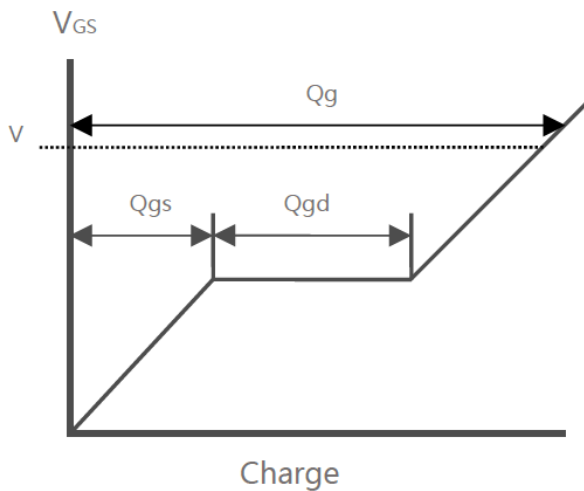

12. Switching Time Waveform

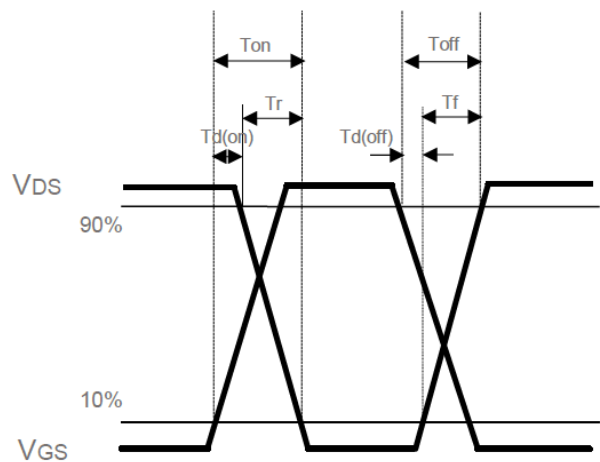



PACKAGE INFORMATION

Dimension in DFN8(3.3x3.3) (Unit: mm)

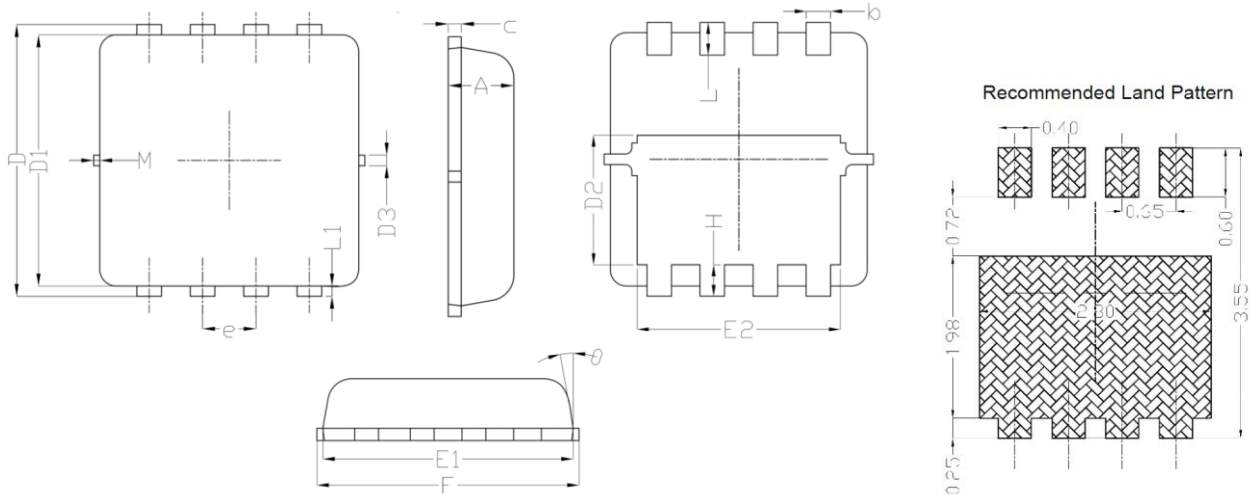

Symbol	Millimeters		Inches	
	Min	Max	Min	Max
A	0.700	0.800	0.028	0.031
b	0.250	0.350	0.010	0.014
c	0.100	0.250	0.004	0.010
D	3.300	3.400	0.130	0.134
D1	3.250	3.450	0.128	0.136
D2	1.780	1.980	0.070	0.078
D3	-	0.130	-	0.005
E	3.200	3.400	0.126	0.134
E1	3.000	3.200	0.118	0.126
E2	2.390	2.590	0.094	0.102
e	0.65 BSC		0.026 BSC	
H	0.300	0.500	0.012	0.020
L	0.300	0.500	0.012	0.020
L1	-	0.130	-	0.005
M	-	0.150	-	0.006
θ	0°	12°	0°	15°



IMPORTANT NOTICE

AiT Semiconductor Inc. (AiT) reserves the right to make changes to any its product, specifications, to discontinue any integrated circuit product or service without notice, and advises its customers to obtain the latest version of relevant information to verify, before placing orders, that the information being relied on is current.

AiT Semiconductor Inc.'s integrated circuit products are not designed, intended, authorized, or warranted to be suitable for use in life support applications, devices or systems or other critical applications. Use of AiT products in such applications is understood to be fully at the risk of the customer. As used herein may involve potential risks of death, personal injury, or server property, or environmental damage. In order to minimize risks associated with the customer's applications, the customer should provide adequate design and operating safeguards.

AiT Semiconductor Inc. assumes to no liability to customer product design or application support. AiT warrants the performance of its products of the specifications applicable at the time of sale.